

All partition information, details and specifications subject to confirmation by Drywall Contractor and are to be in accordance with Manufacturers design and instructions. Architect to be notified immediately upon discovery of variation to the details shown.

These drawings have been edited in accordance with Willmott Dixon's instructions. All material, product, volume, dimension and performance information is indicative only, FCG repudiate any and all liability for failure or non performance of any of the above mentioned items as indicated on this or any other FCG documentation.

NOTES: Do not scale this drawing. All dimensions to be checked on site prior to commencement or manufacture.

Key Plan
1:1000

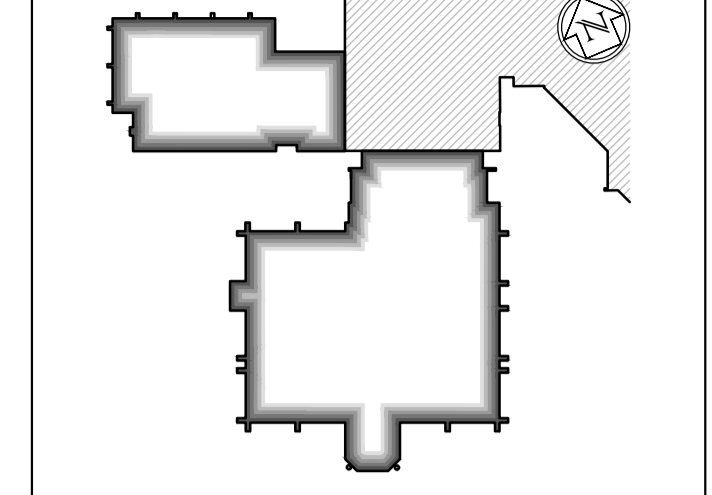

Partition Strategy Key

- WA WA WA WA WA WA 70mm C-Stud & 2 layers 15mm soundbloc - no quilt
- WB WB WB WB WB WB 70mm C-Stud & 2 layers 15mm soundbloc - 50mm 1200 quilt
- WC WC WC WC WC WC 70mm C-Stud & 2 layers 15mm soundbloc - 50mm 1200 quilt
- WD WD WD WD WD WD 70mm C-Stud & 2 layers 15mm soundbloc - 50mm 1200 quilt
- WE WE WE WE WE WE 70mm C-Stud & 2 layers 15mm soundbloc - 50mm 1200 quilt
- WF WF WF WF WF WF Masonry substrates - generally to have 13mm wet plaster finish
- WG WG WG WG WG WG New glazed elements
- WH WH WH WH WH WH IWL 9290 Uni-insulated
- WI WI WI WI WI WI 2 layers 15mm soundbloc on Gyproc Gyframe MF10 metal channels secured on adhesive dabs with 6mm parge coat to existing masonry wall
- WJ WJ WJ WJ WJ WJ Glazed balustrade system with vertical posts carrying stainless steel handrail

Note
All existing external walls dry-lined using thermal board.
All existing fair-faced internal blockwork partition walls to be dry-lined.

Refer also to the following FCG drawings:
For 'GA Plans', refer to drawings 'A-100-Series'.
For 'GA Sections', refer to drawings 'A-200-Series'.
For 'GA Elevations', refer to drawings 'A-300-Series'.
For 'Acoustic Strategy', refer to drawings 'A-150-Series'.
For 'Internal Fire Strategy', refer to drawings 'A-160-Series'.
For 'Builders Work', refer to drawings 'A-180-Series'.
Refer also to detailed drawings generally - 'A-400-Series' + NBS.

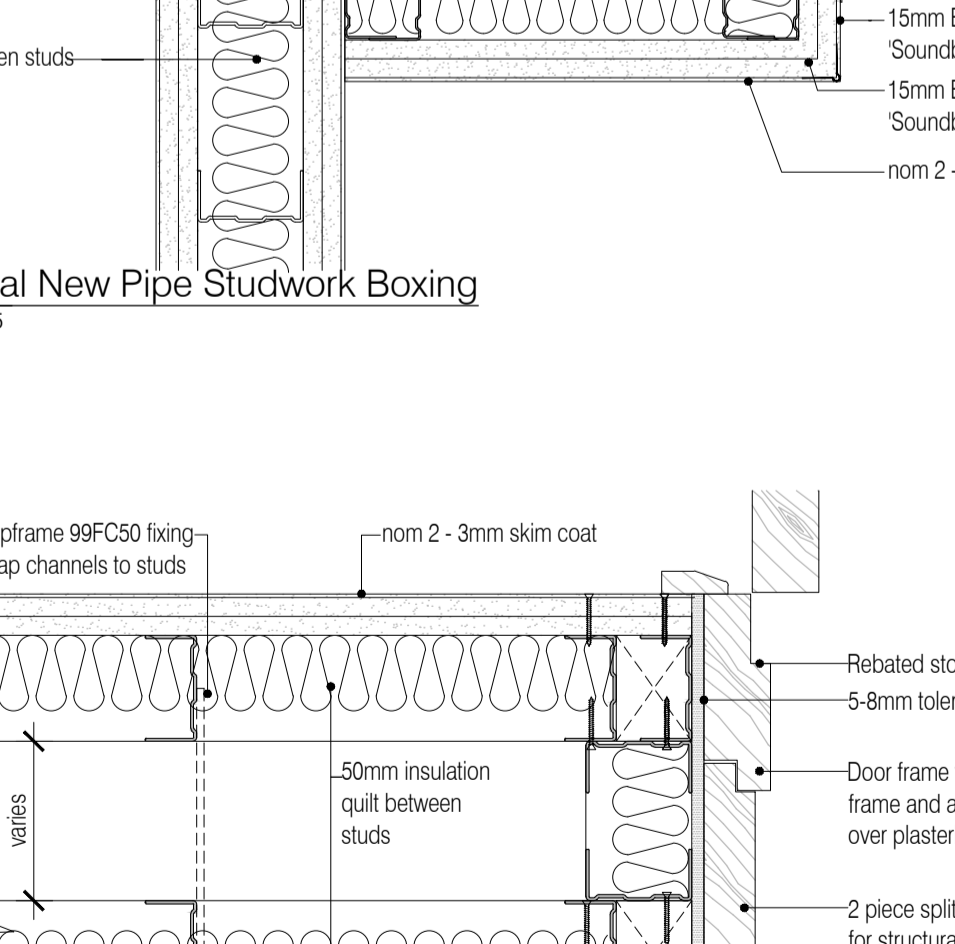
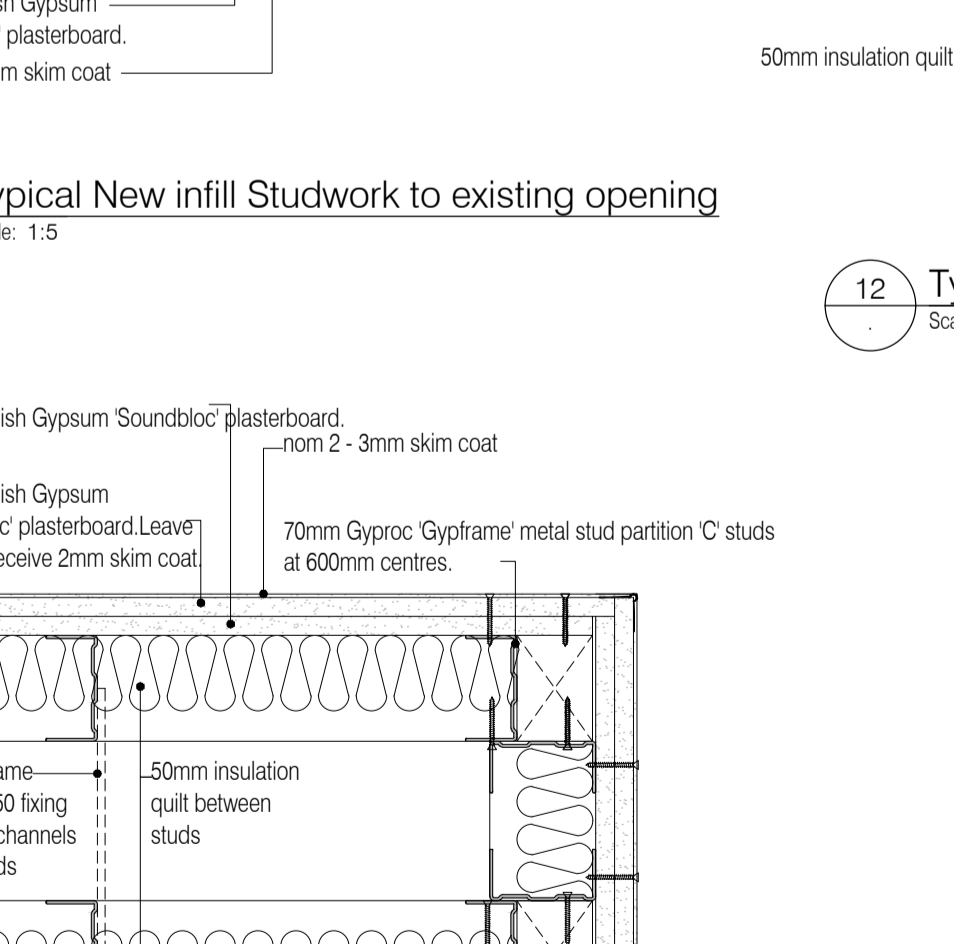
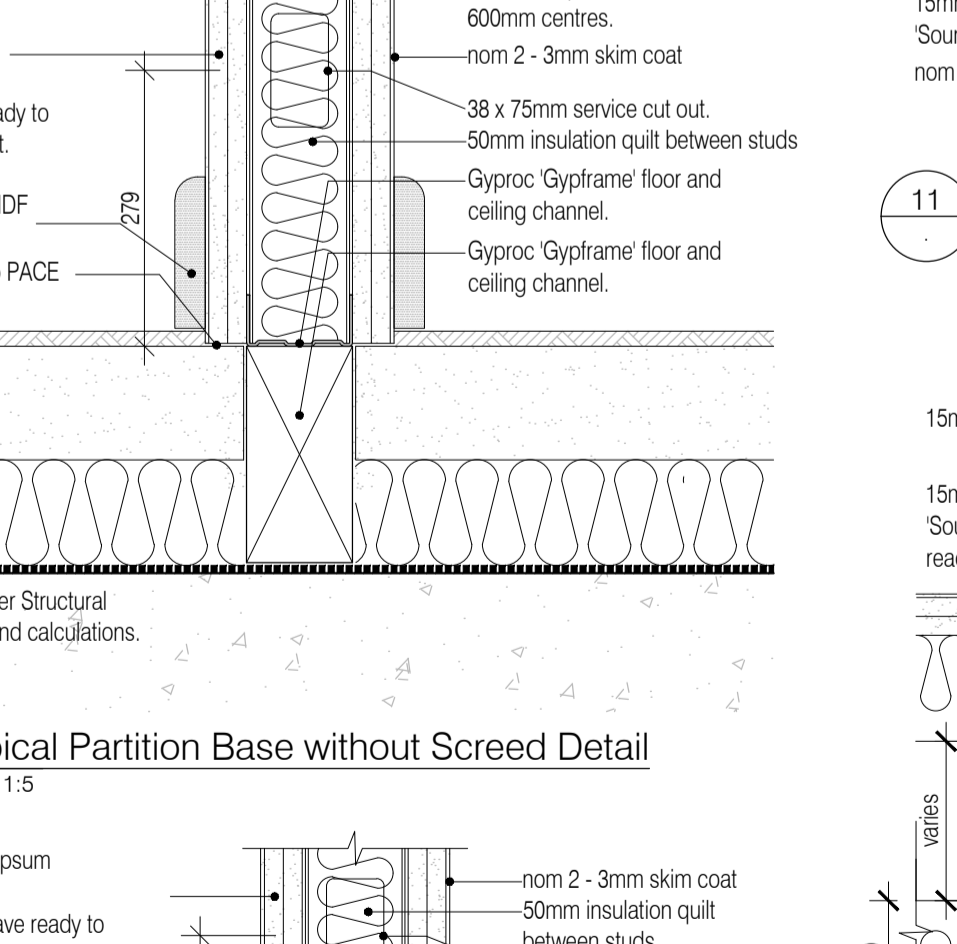
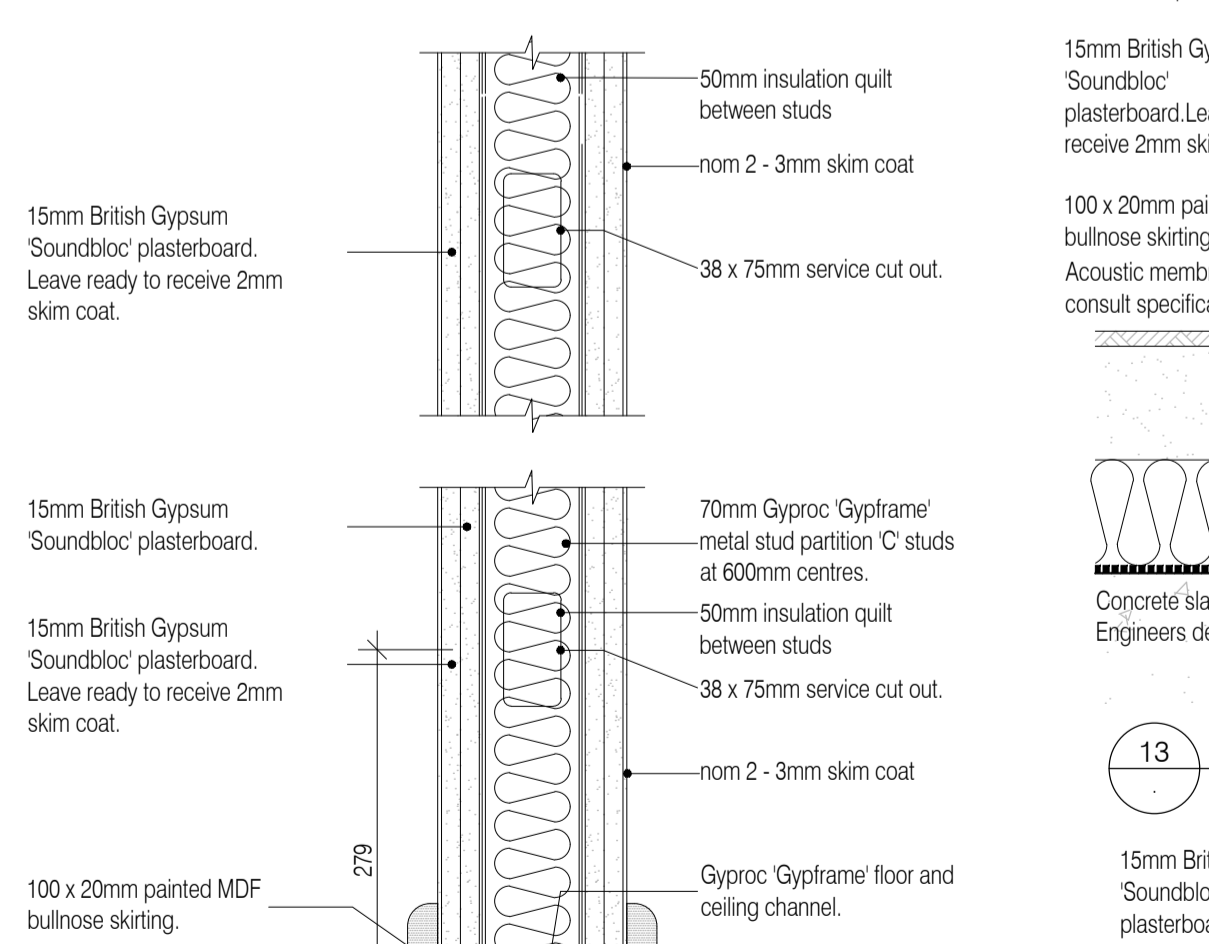
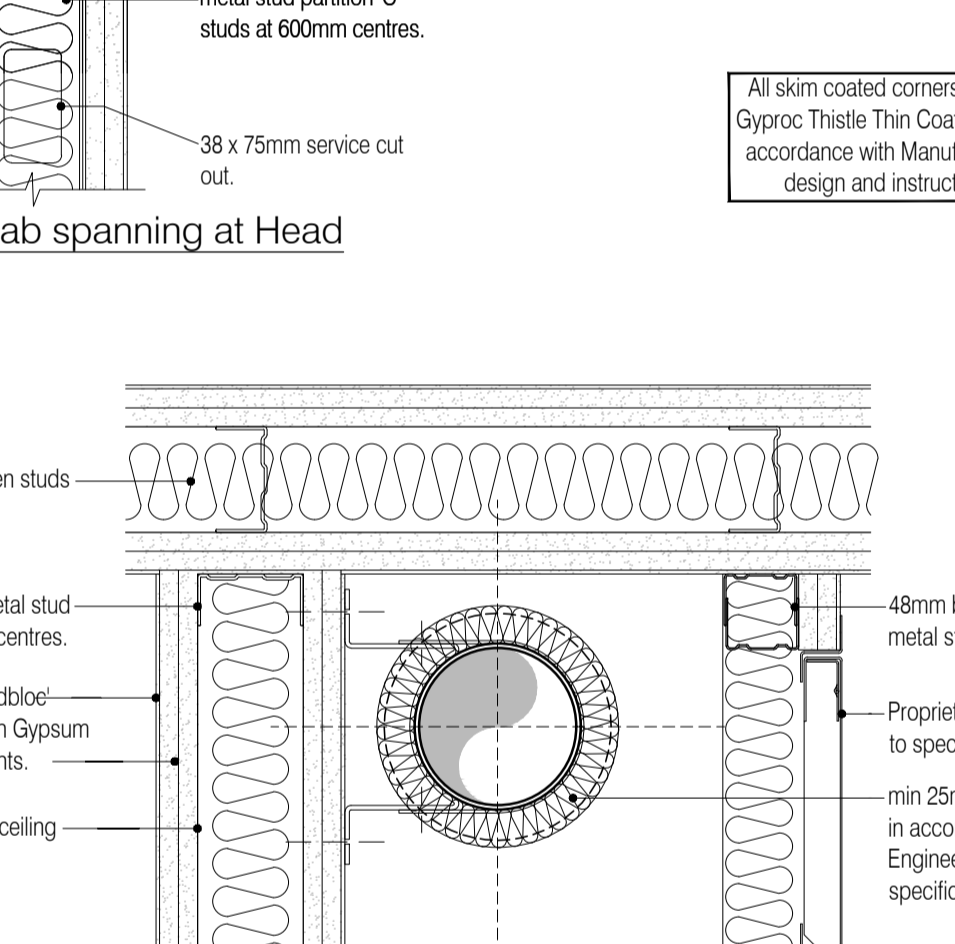
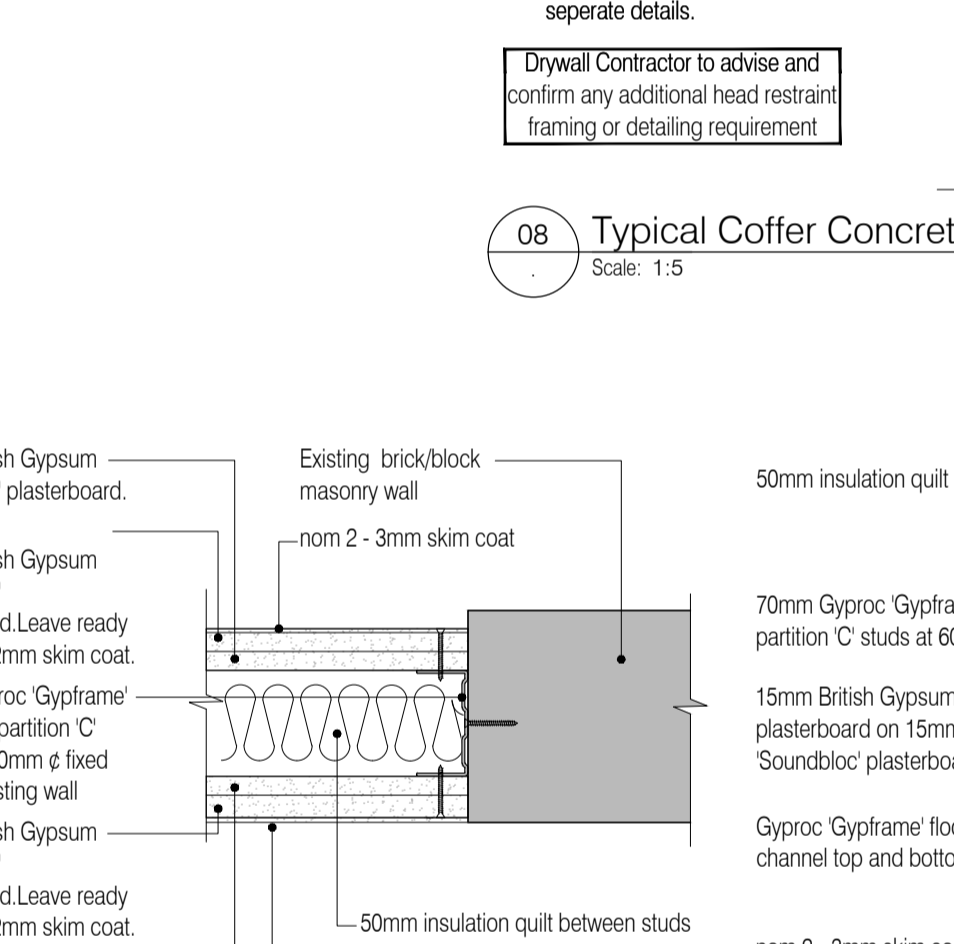
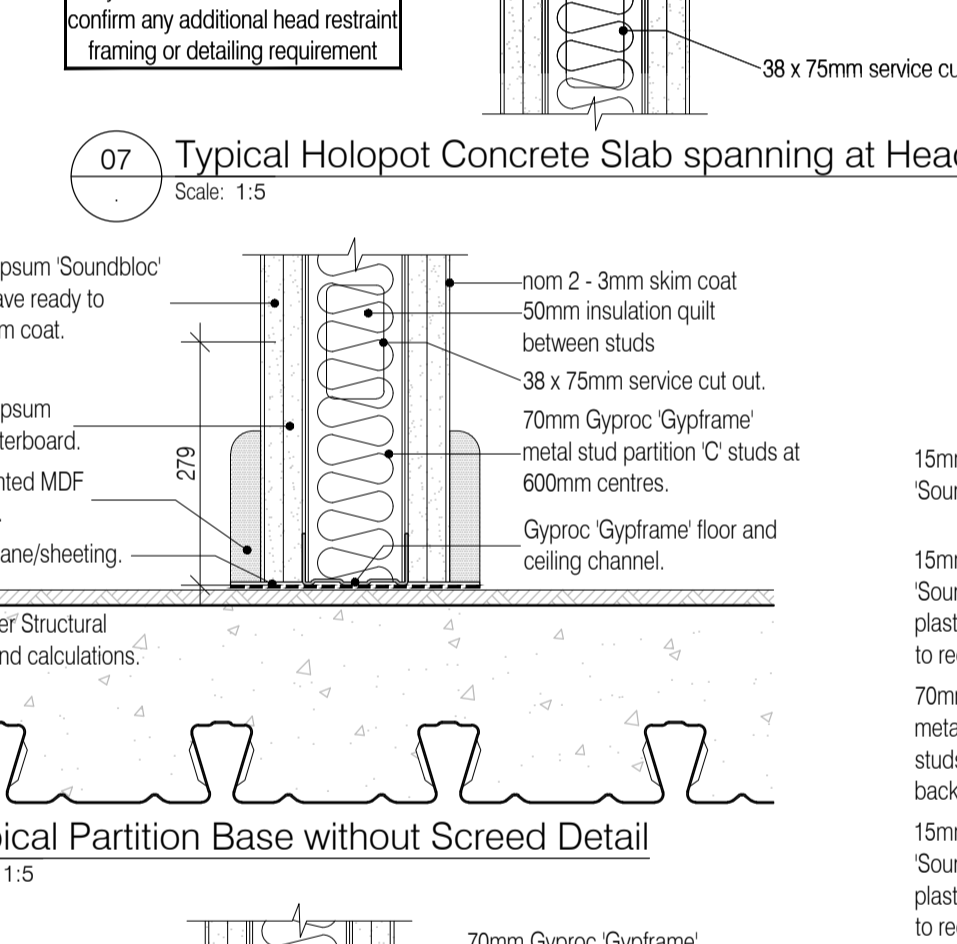
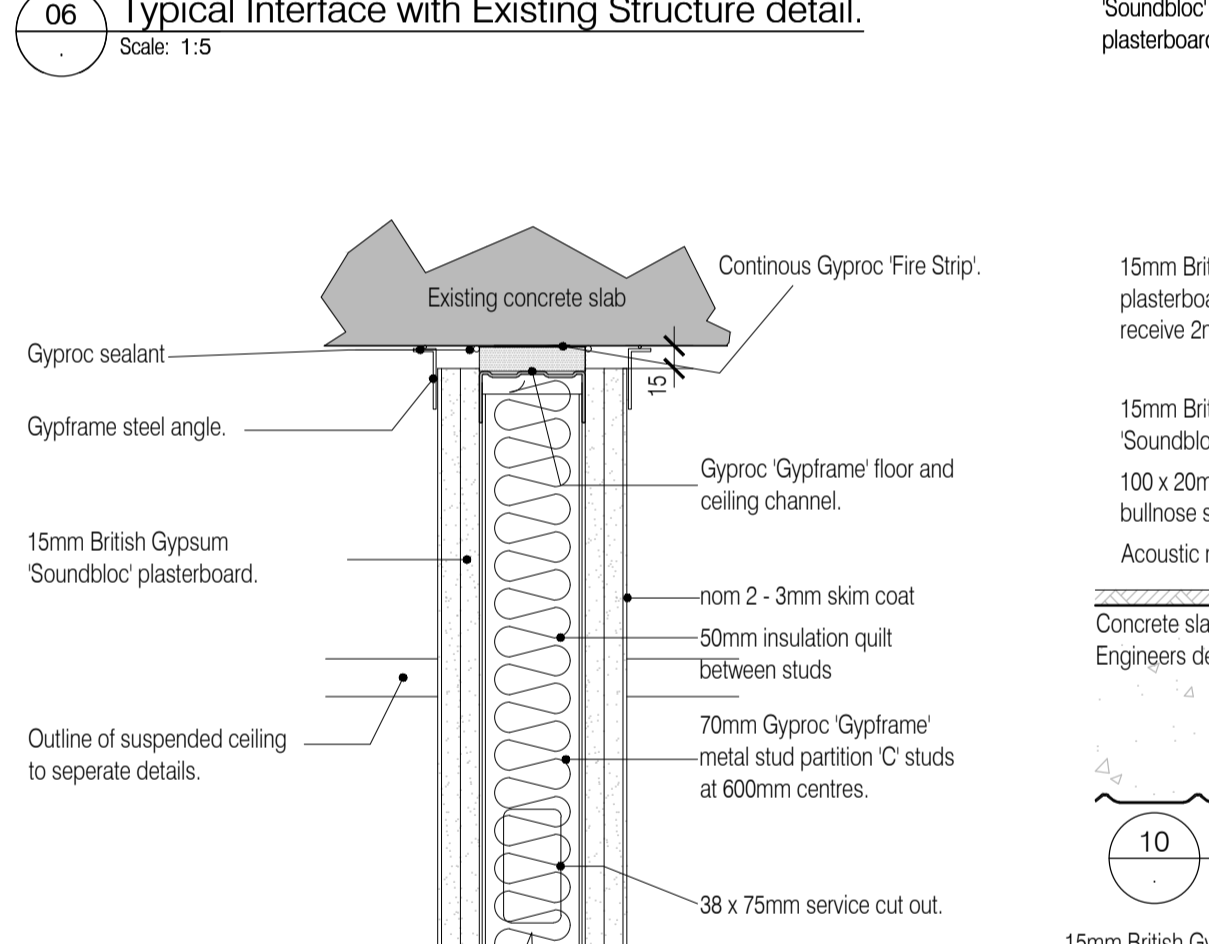
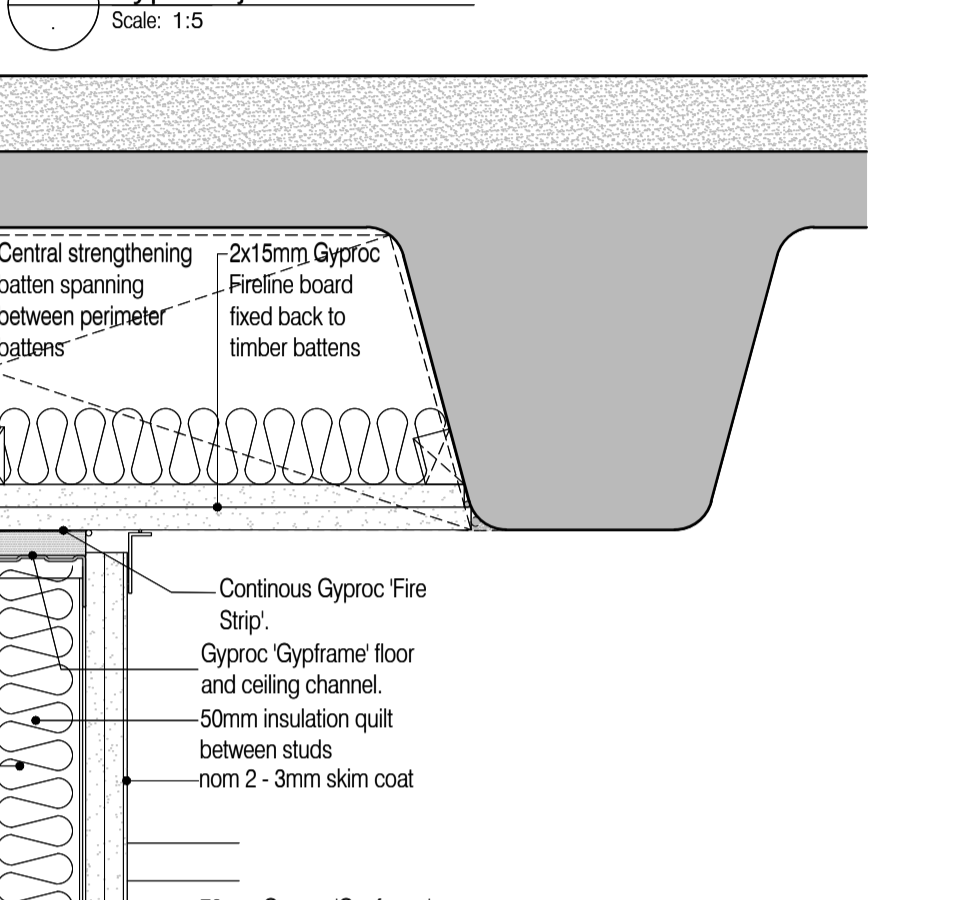
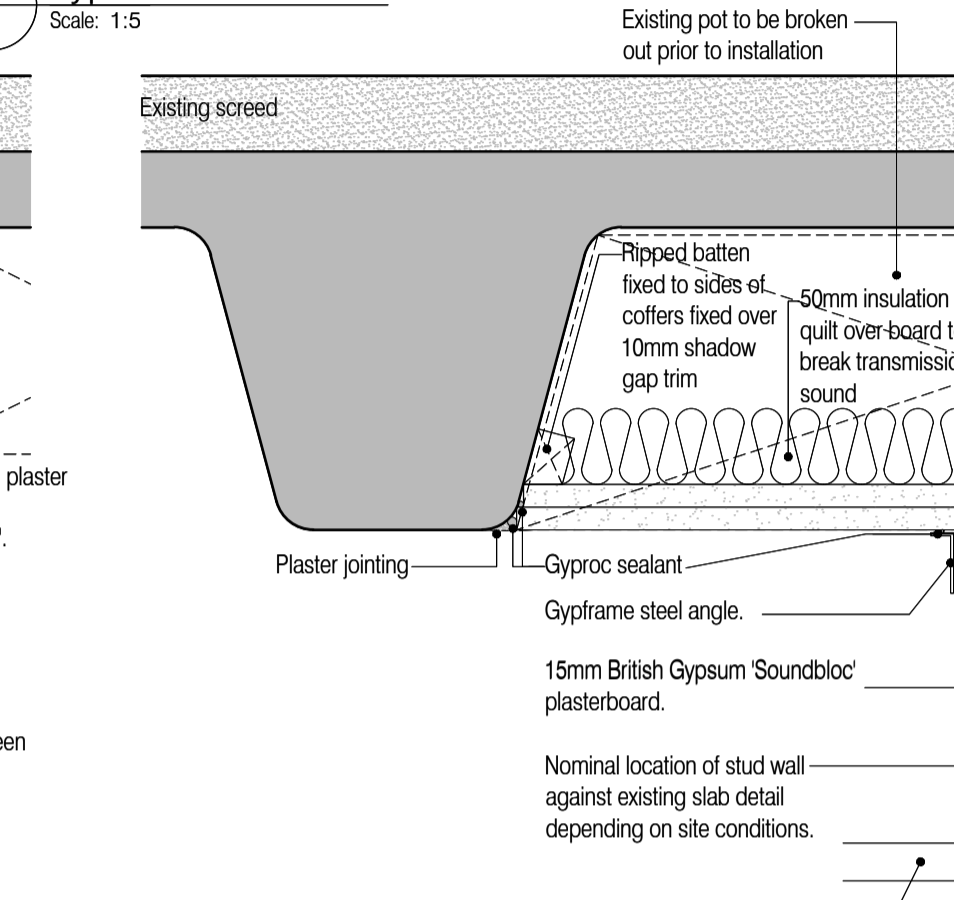
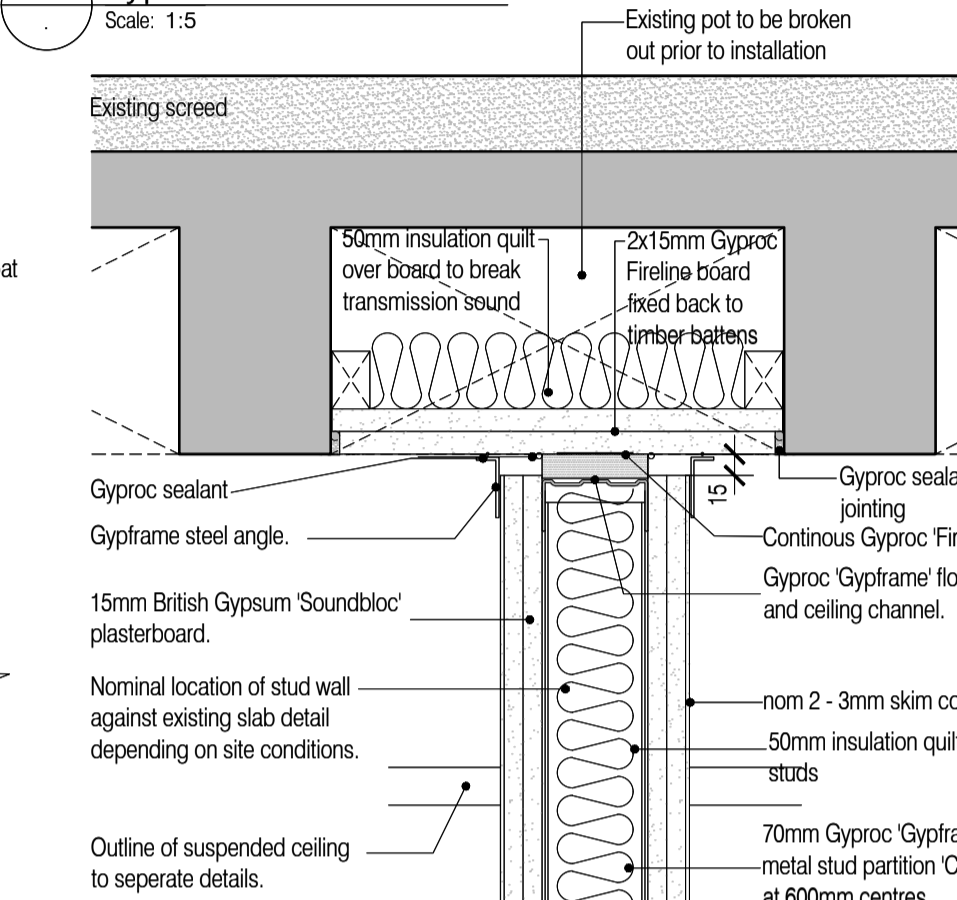
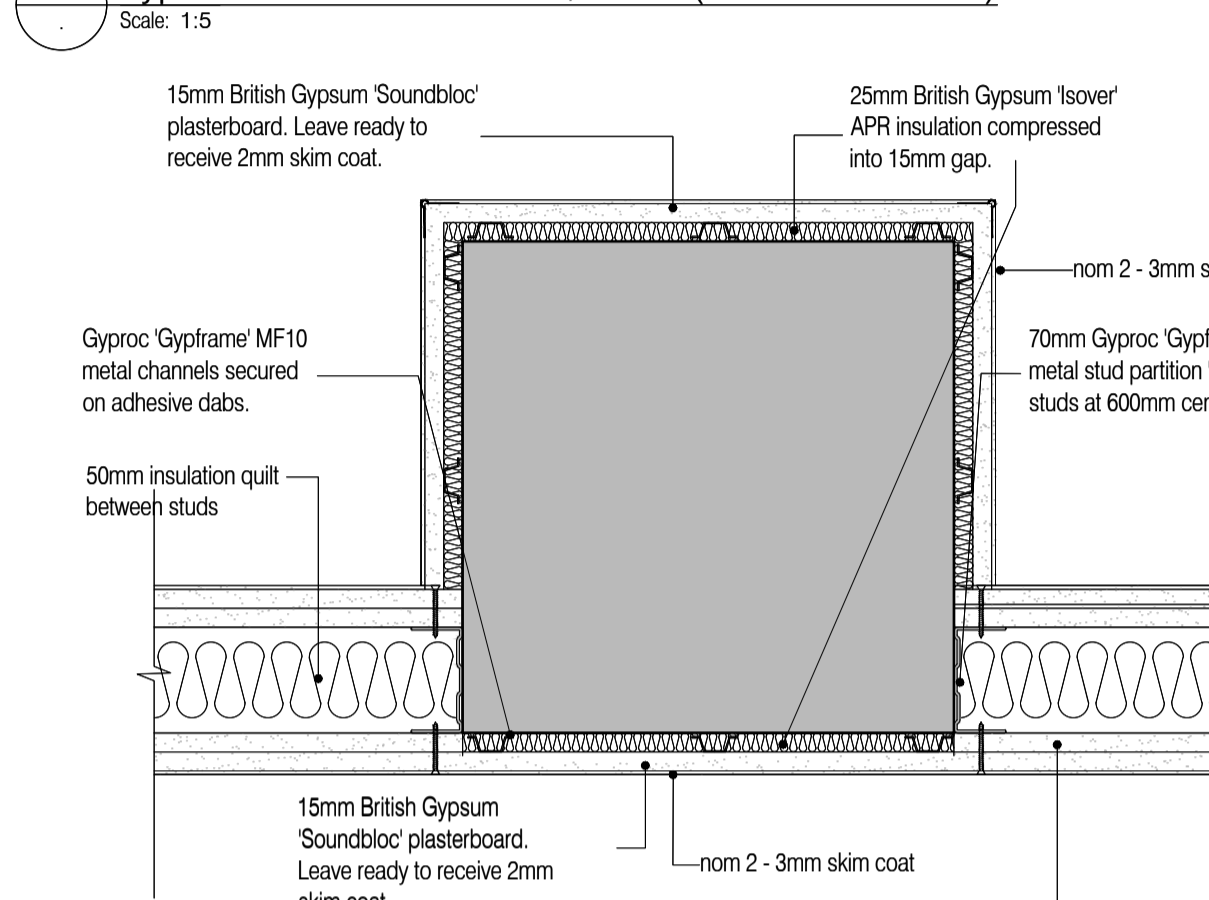
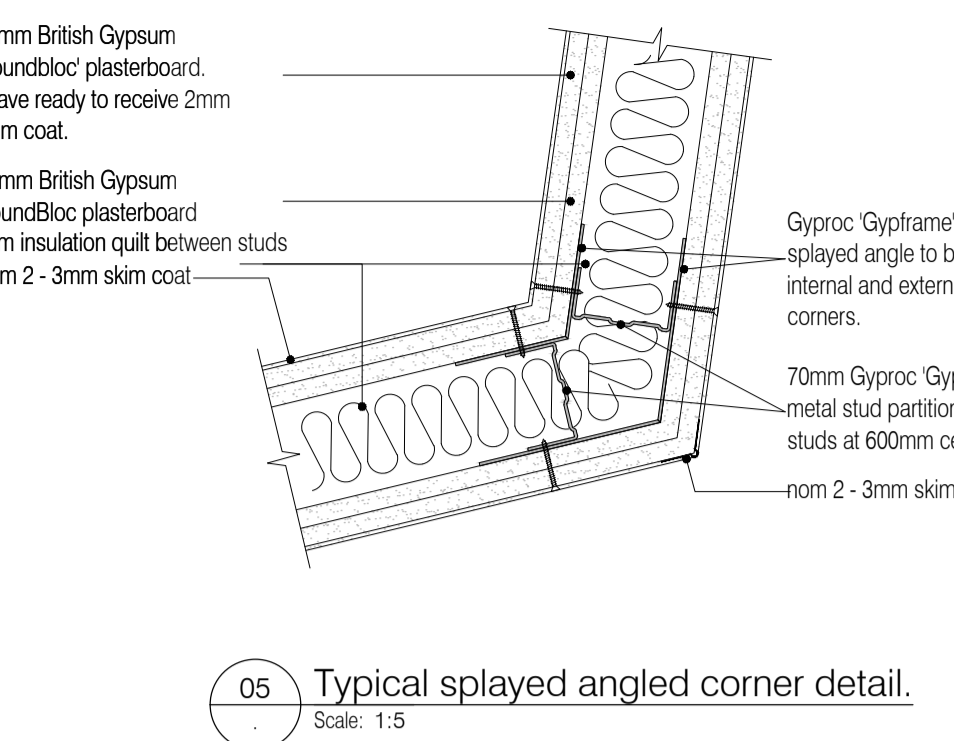
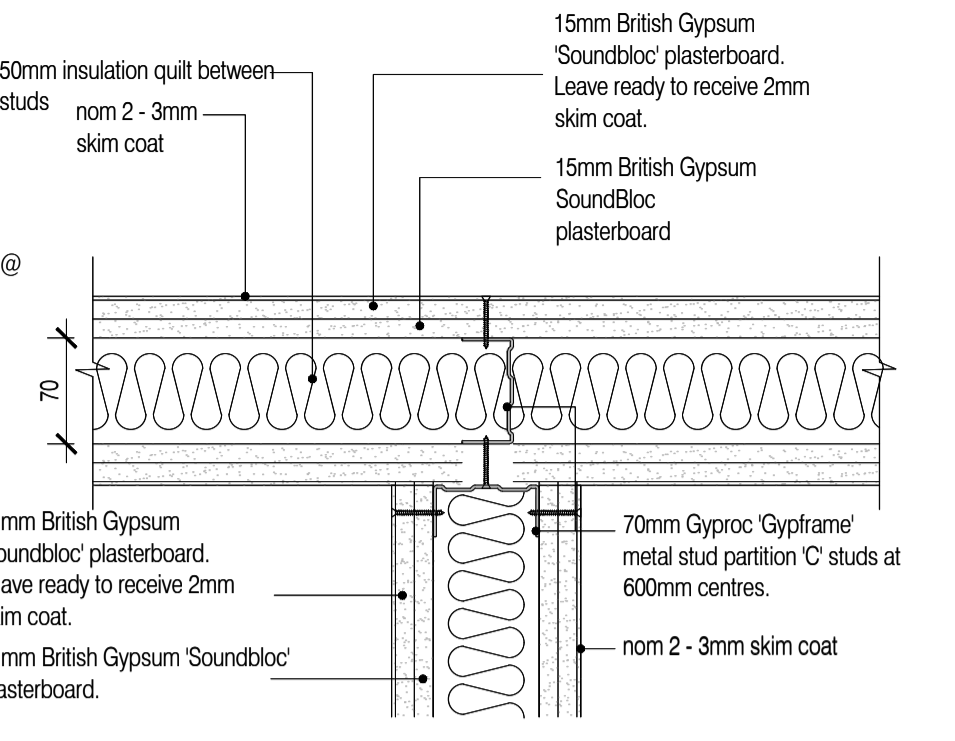
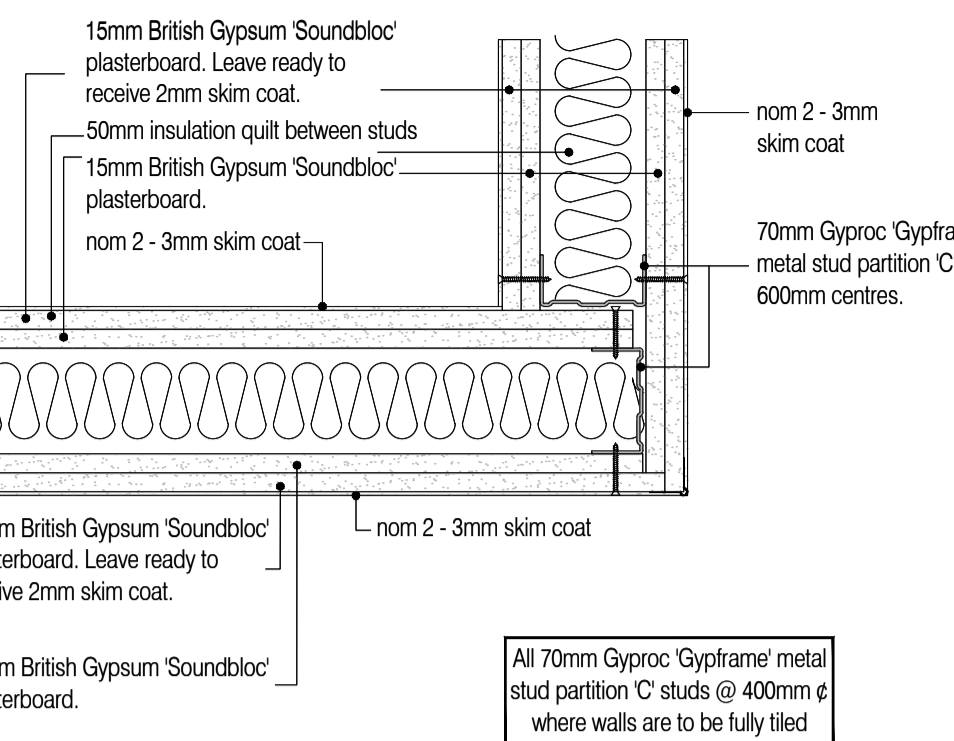
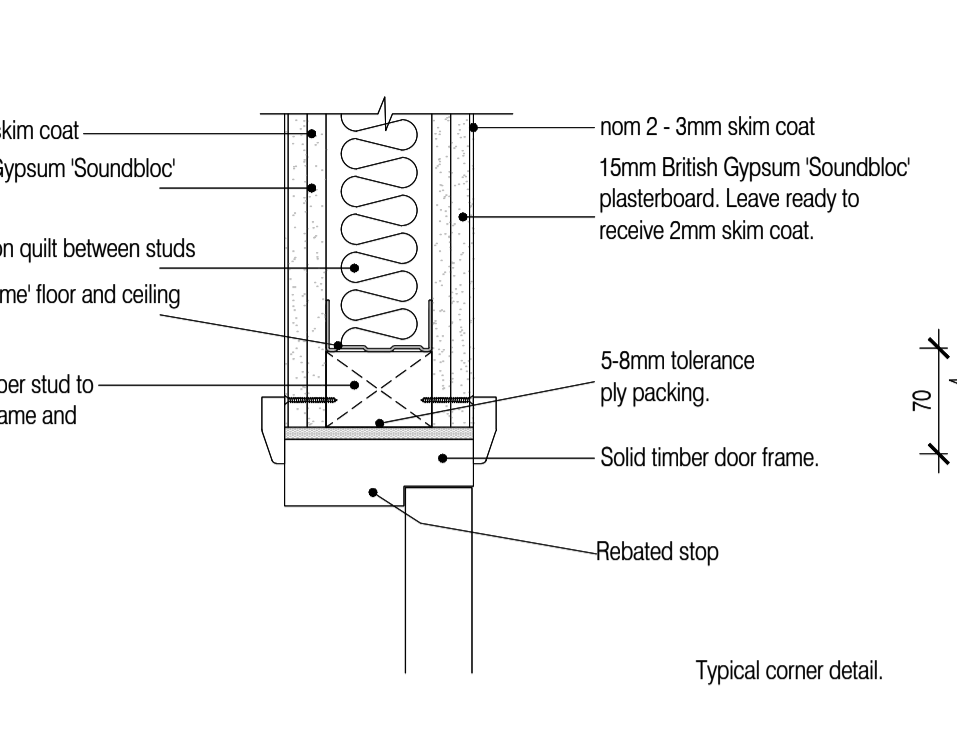
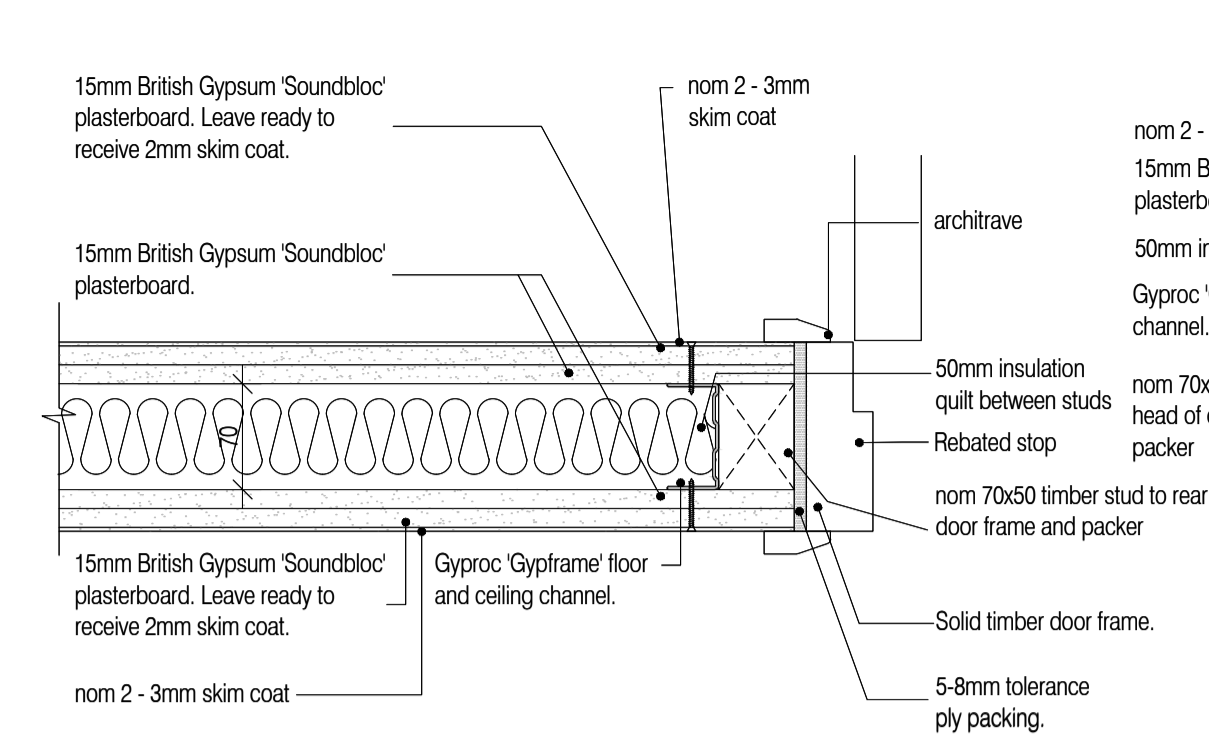

ISSUED FOR CONSTRUCTION

NB: - Solid gray hatch denotes existing building fabric.

Rev	Date	By	Crk	Comment
A	16.09.11	RKC	JAS	Status change - Issued for CONSTRUCTION

BRINGING IDEAS TO LIFE

FRANKHAM

Frankham Consultancy Group Limited
21 Perrywood Road
Haywards Heath RH16 3TP
t 01444 444900 f 01444 455642
enquiry@frankham.com
www.frankham.com

Client
WILLMOTT DIXON CONSTRUCTION

Project Title
Wealden District Council
Hailsham Head Quarters
Refurbishments and Alterations

Drawing Title
Typical Partition Details
Wall Type C Partitions
'WC'

Drawn by: RKC Scale: 1:5@A1 Date: 08.06.11
Designed by: FCG Checked by: JAS Approved by: AC

File Ref.: F:\FRANKHAM\CG2116\WEALDEN\DOOR\46_460_DETAL_050610.DWG 20.06.11 16:26:15

Drawing No. 521185-A-462 Rev. A

NB: All information based on supplied third party survey information. All discrepancies to be reported to FCG immediately upon discovery.

All Mechanical & Electrical and Structural information shown indicative only. Please refer to Mechanical & Electrical and Structural documentation.