

All Disabled and Ambulant Disabled facilities to comply with Approved Document Part M - Access to and use of buildings, Disability Discrimination Act 1995 and BS83000 as required

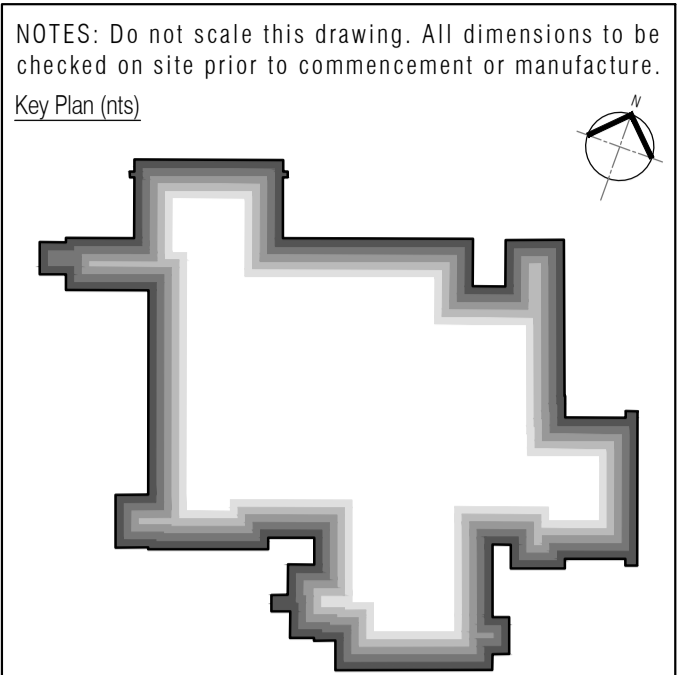

- Partition Strategy Key
- WA 70mm C-Stud & 1 layer 15mm Duralene plasterboard each side - no quilt.
 - WB 70mm C-Stud & 1 layer 15mm Duralene plasterboard each side - 25mm quilt.
 - WC 100mm ThermaLite Shield blockwork.
 - WD 100mm ThermaLite HiStrength 7kN blockwork.
 - WE 150mm ThermaLite Shield blockwork.
 - WF 200mm ThermaLite HiStrength 7kN blockwork.
 - WG 102.5mm facing brickwork, 35mm cavity, 65mm insulation, 100mm ThermaLite Shield blockwork.
 - WH 102.5mm facing brickwork, 35mm cavity, 65mm insulation, 100mm ThermaLite HiStrength 7kN blockwork.
 - WI 100mm ThermaLite HiStrength 7kN blockwork, 65mm insulation, Larch horizontal boarding.
 - WJ 100mm ThermaLite HiStrength 7kN blockwork, 65mm insulation, Larch horizontal boarding.
 - WK 100mm ThermaLite HiStrength 7kN blockwork, 65mm insulation, Larch horizontal boarding.
 - WL 100mm ThermaLite HiStrength 7kN blockwork, 35mm cavity, 65mm insulation, 100mm ThermaLite Shield blockwork.
 - WM 100mm ThermaLite HiStrength 7kN blockwork, 35mm cavity, 65mm insulation.
 - WN 70mm C-Stud & 1 layer 15mm Duralene plasterboard - Rockwool quilt.
 - WO 80mm insulation, Larch horizontal boarding over existing castelled concrete cladding panel.
 - WP Aluminium double glazing curtain walling with bespoke Larch fins

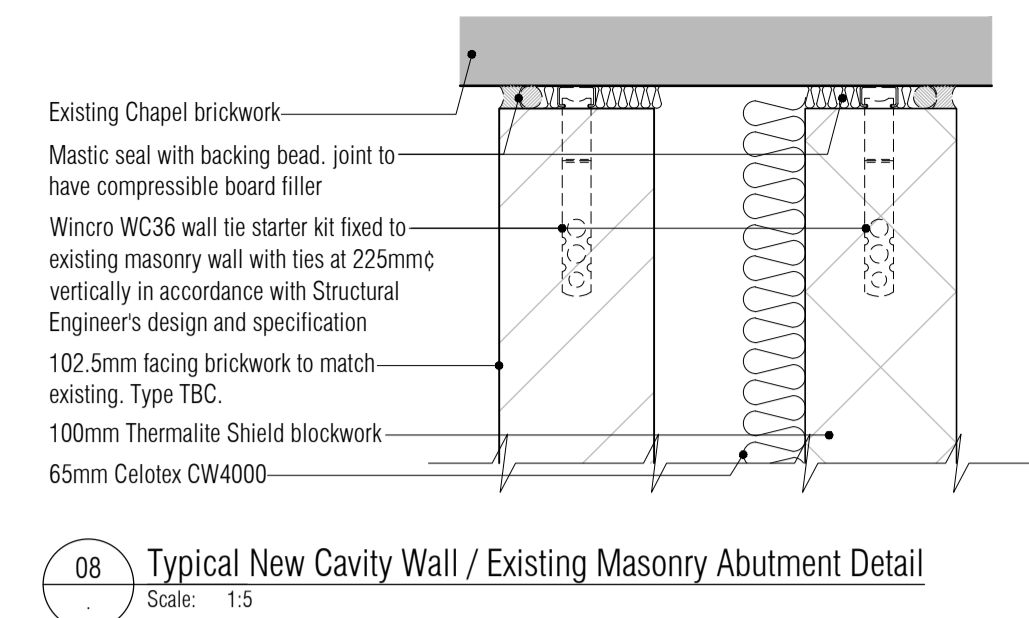
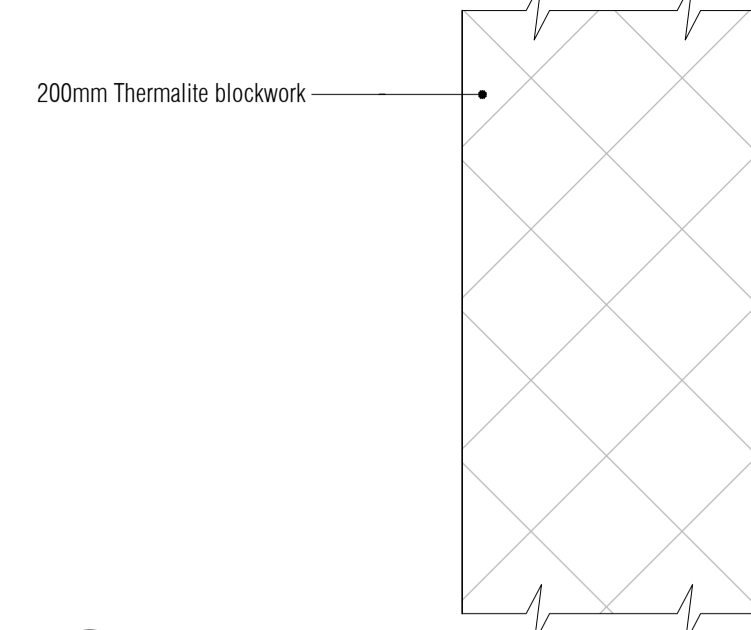
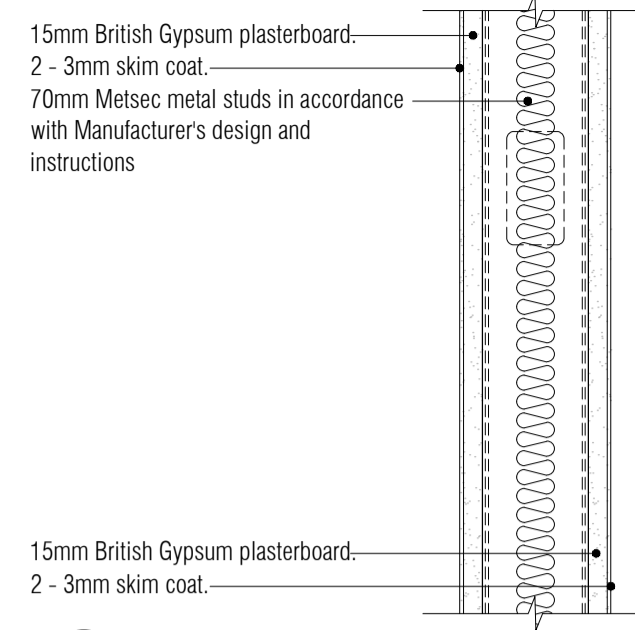
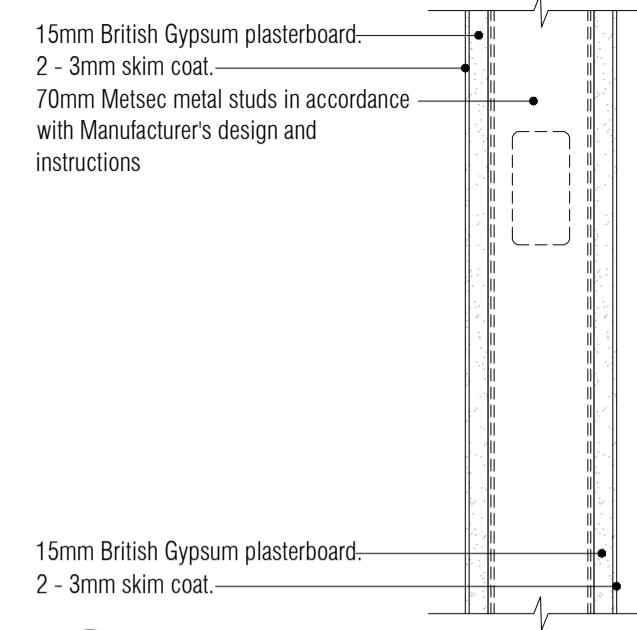
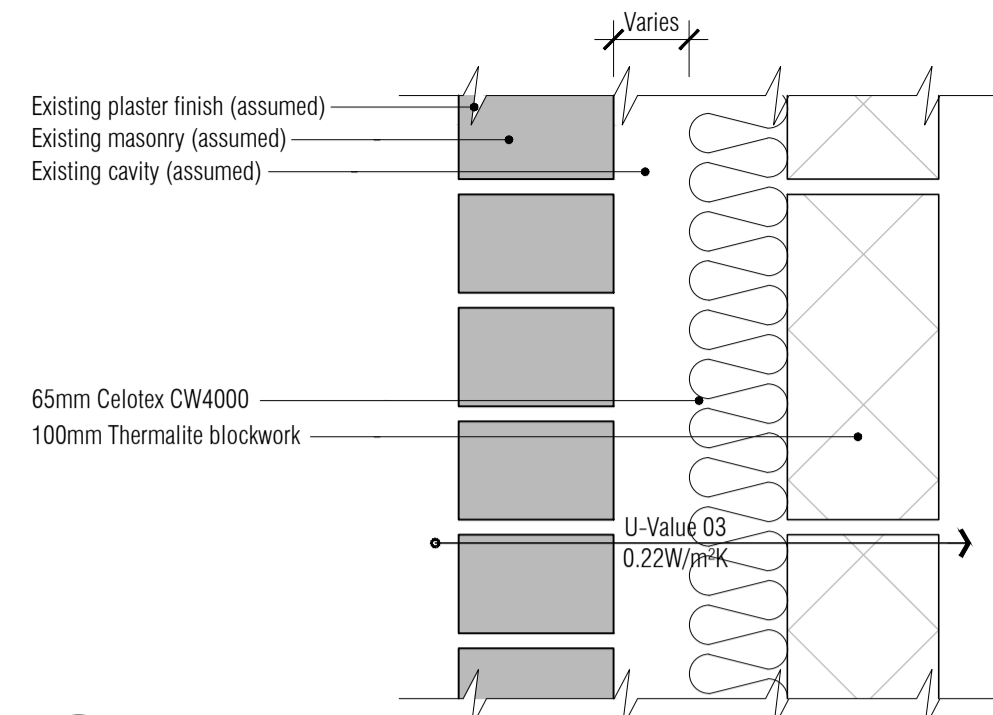
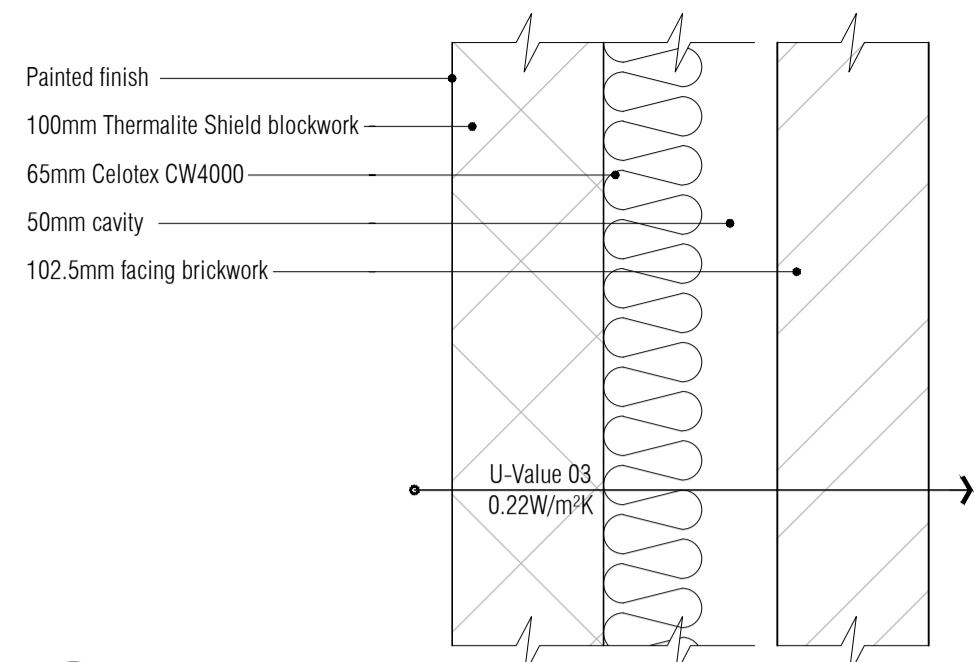
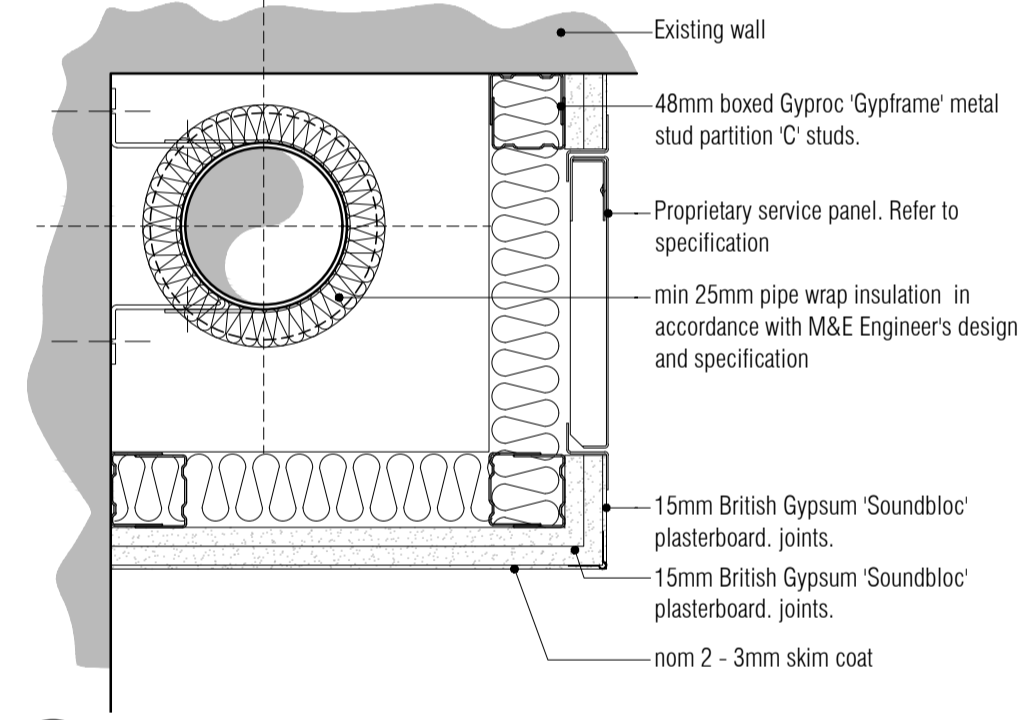
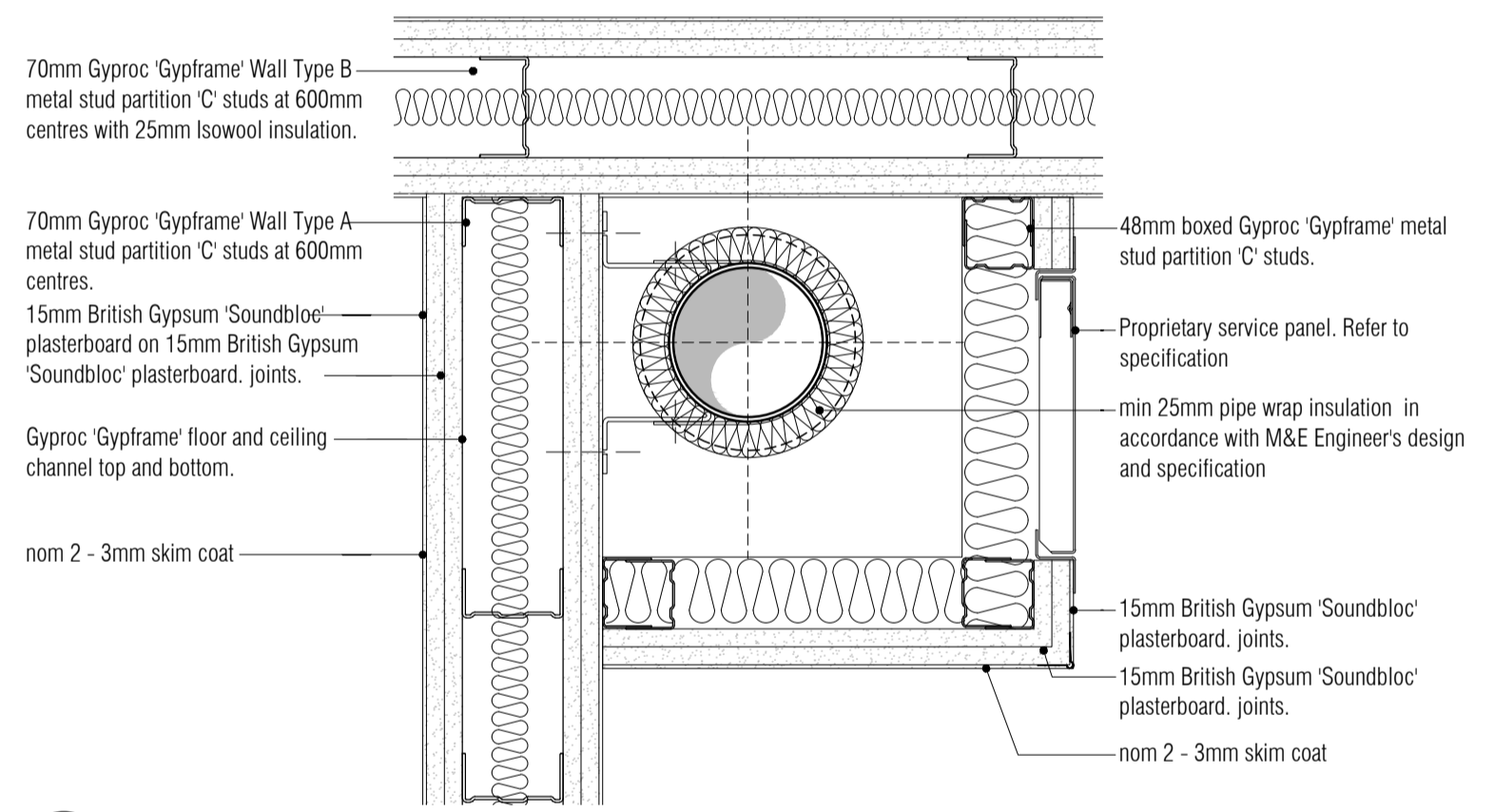
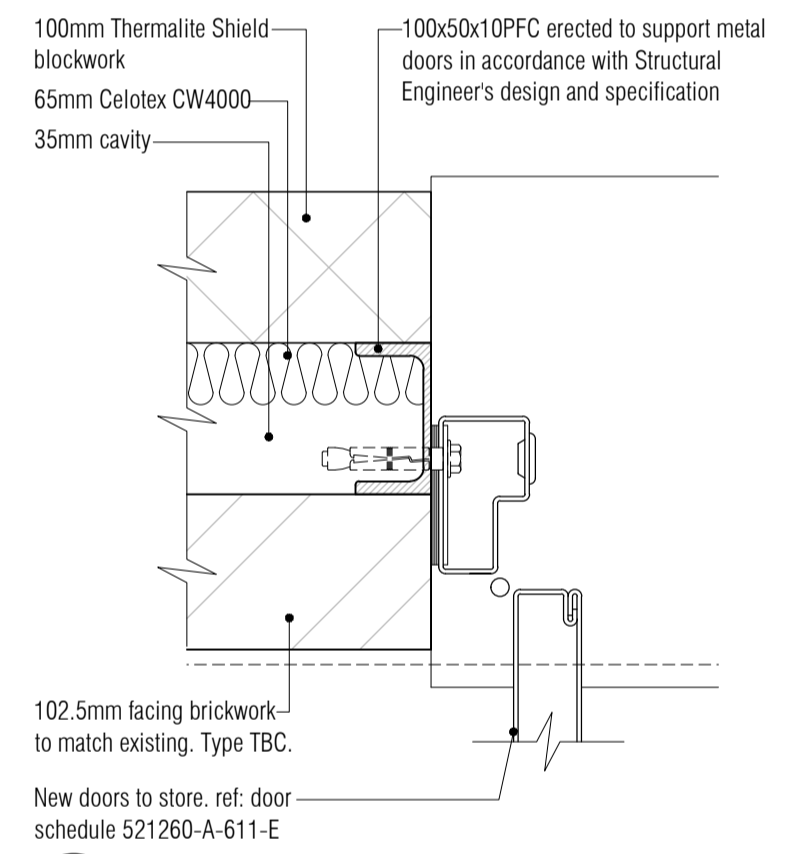
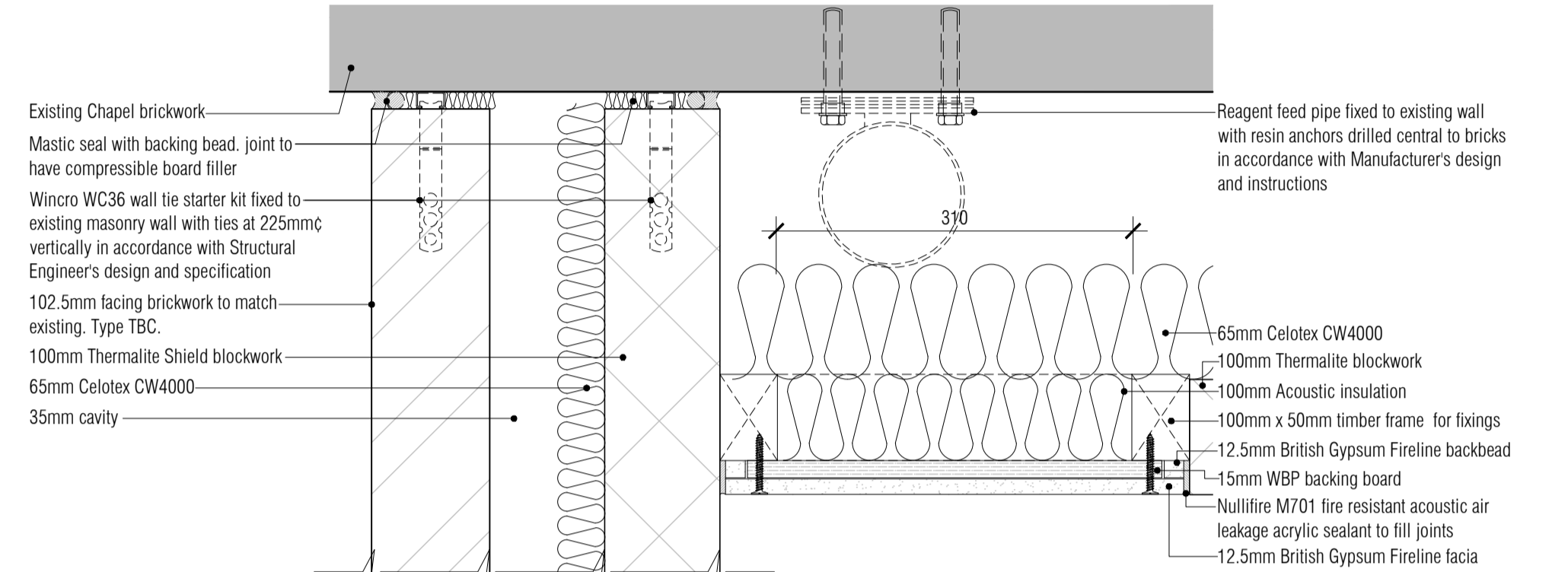
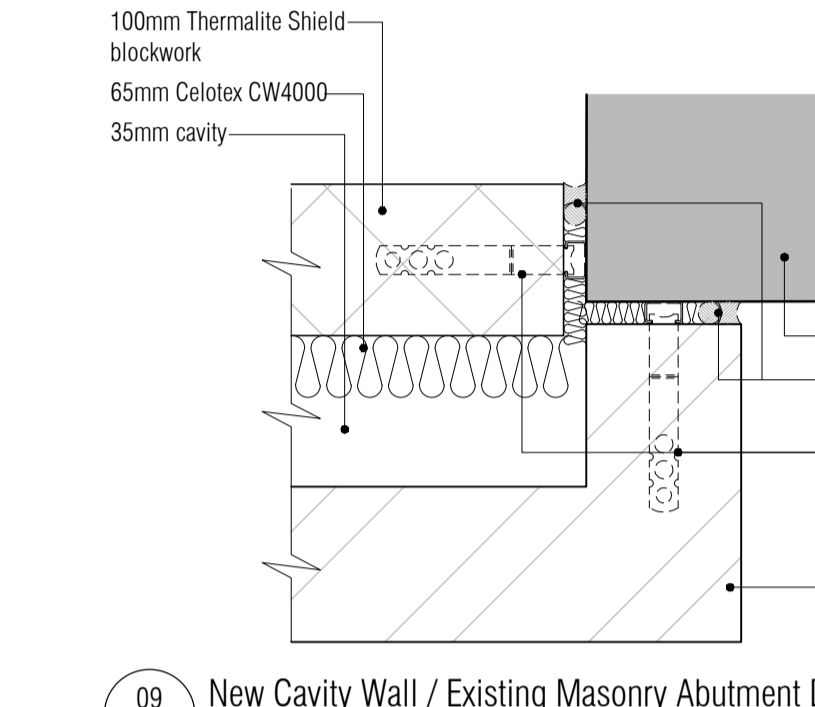
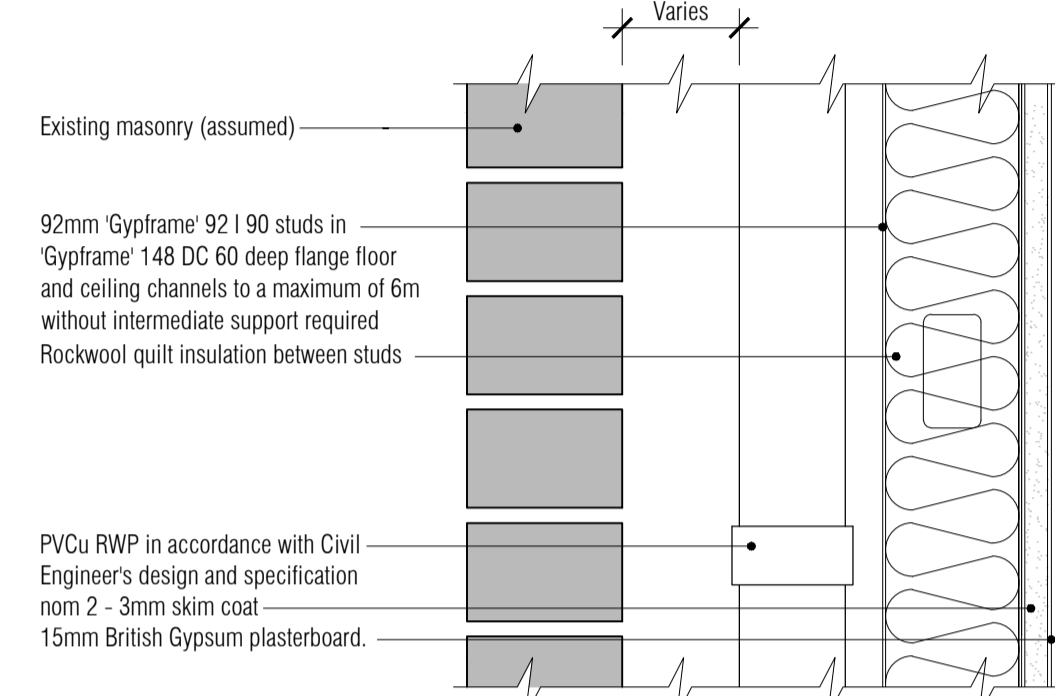
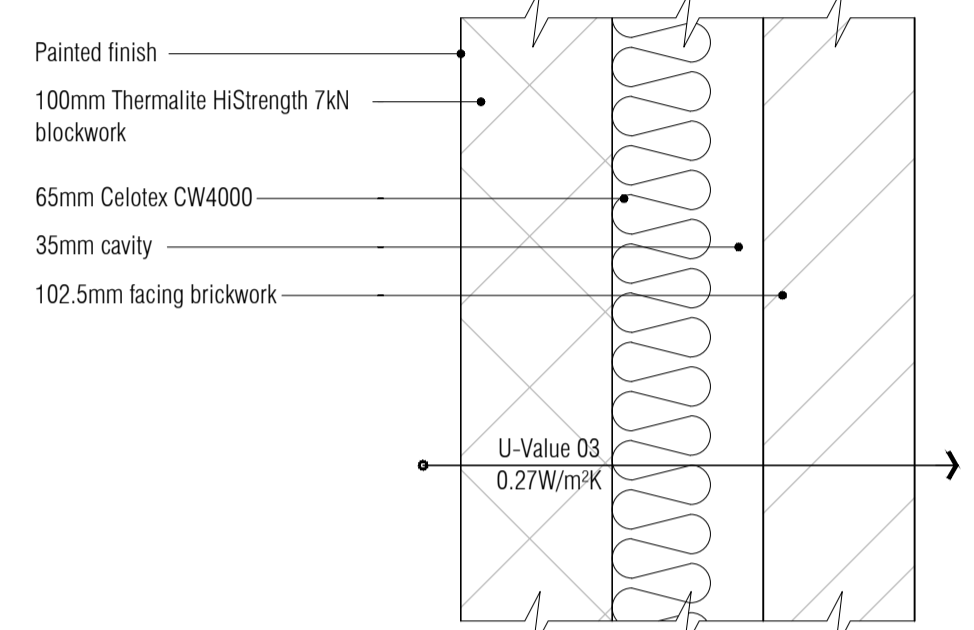

ISSUED FOR CONSTRUCTION

All details referenced in call outs supercede general arrangement or larger depictions.

Rev	Date	By	Chk	Comment
01	29.03.12	RKC	JAS	Issued for CONSTRUCTION

BRINGING IDEAS TO LIFE

FRANKHAM

Frankham Consultancy Group Limited
21 Perrymount Road
Haywards Heath RH16 3TP
t 01444 444900 f 01444 455642
enquire@frankham.com
www.frankham.com

Client

Mansell
Contract N°: MC0269

Project Title

Eastbourne & Worthing
Crematoria
Refurbishments and Alterations

Drawing Title

EASTBOURNE
Eastbourne Crematorium
Wall Typical Details

Drawn by: RKC	Scale: 1:5@A1	Date: 18.10.11
Designed by: FCG	Checked by: JAS	Approved by: AC

File Ref.: X:\FRANKHAM\2\521260-0\DRAWINGS\ARCH\400-01\01.dwg 20.06.11 12:17:02

Drawing No. 521260-A-400-E	Rev. C1
-------------------------------	------------

NB: All information based on supplied third party survey information. All discrepancies to be reported to FCG immediately upon discovery.